

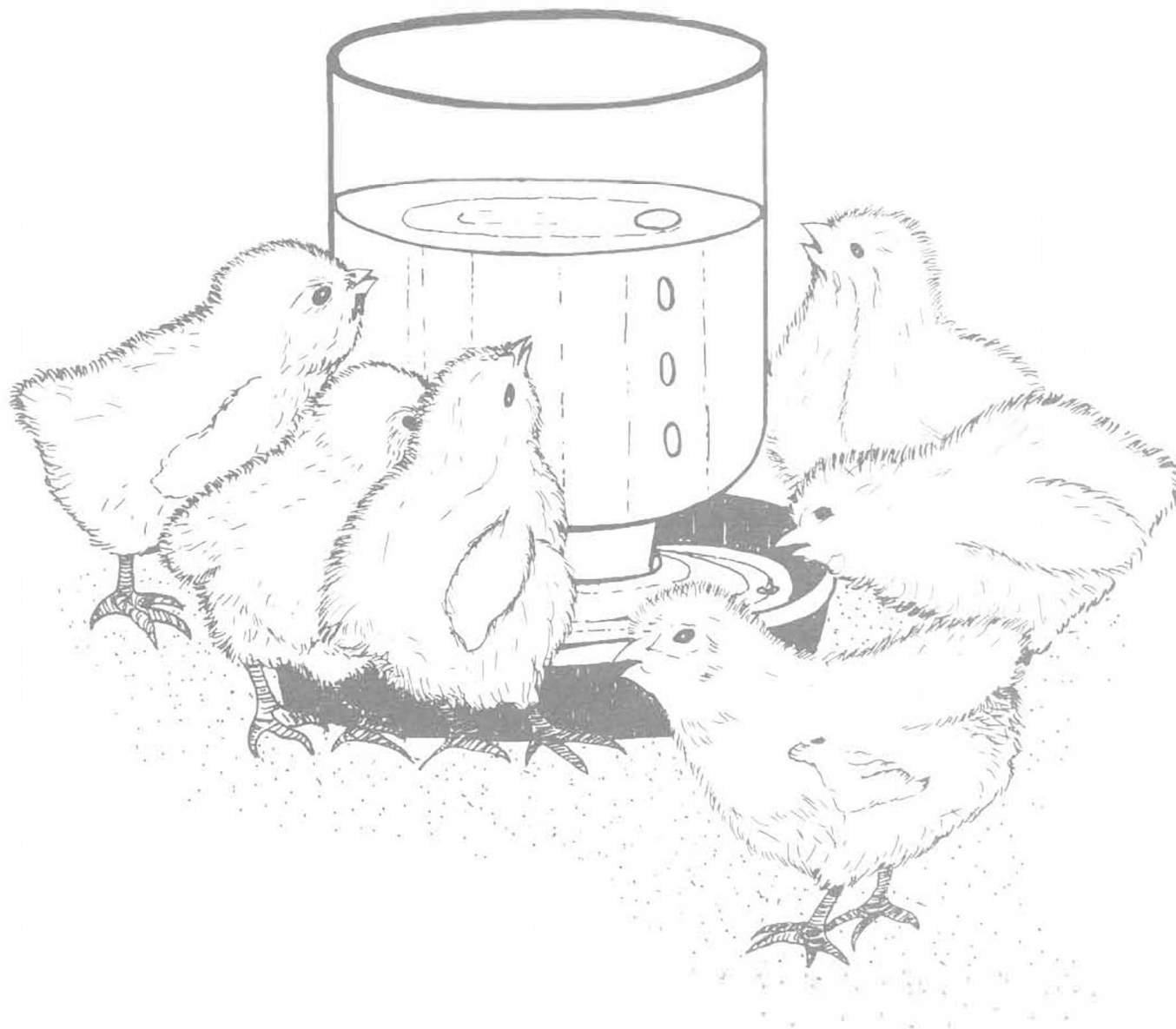

POULTRY PRODUCTION

GROWING BLUE RIBBON PULLETS



Name _____

Club _____

**4-H MATERIAL IN THE
POULTRY PRODUCTION
AND PRODUCTS INCLUDES:**

- 5th Grade — Unit 1 — Growing Blue Ribbon Pullets
- 6th Grade — Unit 2 — Exhibiting Poultry for Pleasure
- 7th Grade — Unit 3 — Poultry Barbecue
- 8th Grade — Unit 4 — Getting Acquainted With Marketing
- 9th Grade — Unit 5 — Growing Hobby-type Chickens
- 10th Grade — Unit 6 — Creative Egg Cookery
- 11th Grade — Unit 7 — Commercial Broiler and Egg Production
- 12th Grade — Unit 8 — Poultry Careers

The material in this publication was adapted and prepared for use in Tennessee by R.W. Bastien, former Assistant Professor, and H. Charles Goan, Professor, Animal Science.

TABLE OF CONTENTS

Introduction	4
Project Requirements	4
Objectives	4
Breed Selection	5
Where to Buy Chicks	5
How Many Chicks to Buy	6
When to Start Brooding	6
Housing Requirements	6
Brooding Chicks	7
Poultry Nutrition	11
Disease Prevention	12
External Parasites	13
Internal Parasites	13
Vaccination	13
Growing Pullets	13
Managing Layers	14
Egg Care	15
Culling	15
Project Questions	16
Project Experiment	17
What You Can Show Others	18
Management Timetable	18
References	20

GROWING BLUE RIBBON PULLETS

Introduction

Raising baby chicks for layers or broilers is a popular 4-H project. You can have fun taking care of chickens, and your family will enjoy the good tasting and nutritious food you produce. This project will help you to learn about poultry production and management through experience.

Project Requirements

The purpose of the project is to give you an opportunity to learn about and care for chickens. Your responsibility will be to feed, water and care for your birds daily. The number of chickens you start with will depend on the housing and equipment you now have, or are willing to purchase and construct.

Accurate records must be kept of the entire project, including feed consumption, mortality, equipment purchased and any other items used in the project.

A project story of about 300 words must be written and submitted with other records at the close of the project. A Tennessee 4-H Poultry Record Book, Form 659, has been developed to help keep accurate records, and is available upon request from your local county Extension agent.

Objectives

This project will help you:

- ... develop poultry management skills.
- ... produce healthy chickens.
- ... develop an awareness for business management through keeping records of project, costs and income.
- ... contribute to your home food supply.
- ... realize the pride of accomplishment.

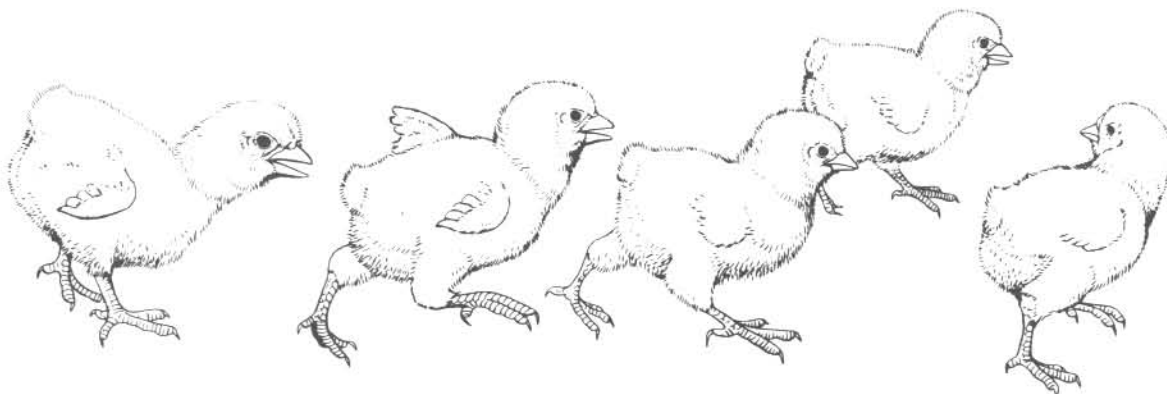

Breed Selection

Before you choose a breed and variety for your project, decide whether you want to raise chickens for eggs or meat.

Egg-type

Single Comb White Leghorns and Leghorn-type hybrids are used for egg production. These birds live well, grow fast, and begin laying eggs at 5 to 5½ months of age. They have small bodies and do not consume as much feed as larger meat-type birds. They have been bred to lay a large number of high-quality, white-shelled eggs.

The Leghorn-type cockerel does not grow fast and does not make a good broiler. If you select egg-type birds, buy only female chicks.

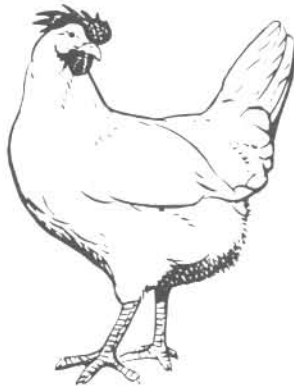

Meat-type

The meat-type birds are a cross between a strain of cornish game and a brown-egg meat-type bird such as White Rocks, Columbians, and New Hampshires.

Broiler-type chickens convert feed efficiently, grow and feather rapidly, and are ready to dress for home use at 8 to 8½ weeks. They should not be kept for market egg production, because they do not produce eggs as efficiently as egg-type birds.

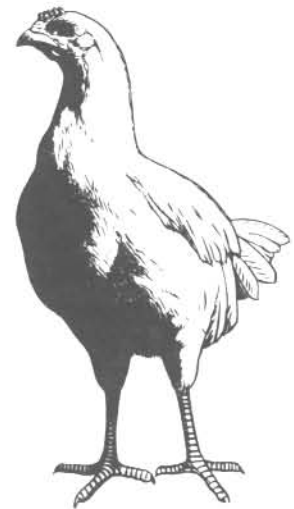

Dual-purpose

The dual-purpose birds were developed to provide the family with both eggs and meat. These birds do not produce eggs as efficiently as birds of the egg-type strains. Nor can they produce meat as efficiently as birds selected for meat production. Dual purpose birds include Rhode Island Reds, White Plymouth Rocks, New Hampshires, Barred Plymouth Rocks, Black Sex Links and Red Sex Links.

Black Sex Links are a cross between a Rhode Island Red male and a Barred Plymouth Rock female. The Red Sex Links are a cross between a Rhode Island Red male and a White Leghorn female.

The dual-purpose birds are hardy, lay large brown-shell eggs, and are well suited for the backyard flock.

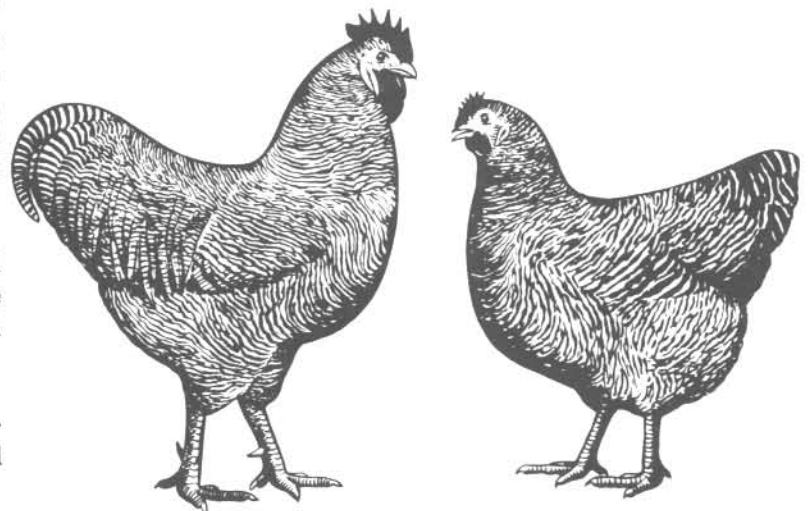

Where To Buy Chicks

Start your project by participating in the 4-H Chick Chain. Each 4-H member who participates in the program receives 25 to 50 free chicks to brood and rear. The 4-H'ers agree to return six or 12 pullets to the show and sale. Contestants receive ribbons and prize money based on their success in raising blue ribbon pullets.

An alternative is to purchase well-bred, healthy chicks from a reputable hatchery that breeds stock for efficient production. The hatchery should be a member of the National Poultry Improvement Plan. These hatcheries blood-test their breeding flocks for pullorum and typhoid, and produce chicks from birds that do not have these diseases. The Agricultural Extension Service agent in your county or the Poultry Extension Specialist, Agricultural Extension Service, Box 1071, Knoxville, Tennessee, 37901-1071, can furnish you with a list of hatcheries which operate under the National Poultry Improvement Plan.

Order your chicks at least four weeks before the date you would like to start them. Be sure to have the hatchery debeak and vaccinate the chicks for Marek's Disease.

How Many Chicks To Buy

Discuss your plans with your parents, giving careful consideration to the following:

1. Size of the poultry house.
2. Brooding equipment such as feeders, waterers, and brooder needed for the project.
3. The amount and cost of feed.
4. Amount of time you can give to your project.
5. Whether you can continue with the project in the fall and winter if you decide to raise birds for egg production.
6. Whether or not you have a market for the eggs or meat.

If you want 25 mature pullets, then you need to purchase approximately 30 to 35 chicks. Purchase only pullets rather than straightrun egg type chicks. A straightrun means a combination of pullets and cockerels. The egg type cockerels grow slower than meat type birds. They require more feed and are very poor converters of feed to meat.

In a broiler flock, a five percent mortality rate is considered high. It will not be necessary to buy many more chicks than you plan to market.

It is important that the flock size be right for the housing space and equipment available. Twenty-five to 50 chicks will provide enough eggs and some meat for your family. A larger flock can become a source of income, provided there is a local demand for your eggs and meat.

When To Start Brooding Chicks

March and April are the months to start chicks for small 4-H laying flocks. It is easier to brood the chicks when the weather is beginning to get warmer, and they will come into production in the fall and winter. If you plan to show your birds in competition they will be more fully developed than chicks hatched at a later date. Leghorn-types will start laying about five months, while the dual-purpose birds will start to lay in about six months.

Chicks purchased for meat production can be started at any time. It takes about 8 to 8½ weeks to produce a 3½-to 4-pound fryer, when a good broiler stock is selected. Since broiler chicks grow fast, they are ready for market soon after the brooding period.

Housing Requirements

You must provide a shelter for your chickens. The birds should be comfortable while in your care. A house protects them from the weather. It also keeps out rodents, wild birds, and large animals. Plans for small poultry houses can be obtained from the Poultry Extension Specialist.

Housing and equipment for chickens does not need to be elaborate or expensive. There are, however, several factors which must be considered in order to grow healthy and vigorous birds. These factors include the following: space, draft-free ventilation, light, temperature, easy access to feed and water, roosts, and nests.

As the birds progress from the brooding period to the growing period, and then to the laying stage, the factors change to meet the birds' needs. As you read the manual, pay attention to these factors. They will help you manage your birds properly.

Brooding Chicks

Baby chicks require lots of tender loving care. They depend on you for all their needs. The brooding period lasts about six weeks. If you practice the following management factors during the breeding period, you should have a healthy flock.

1. **SPACE.** Each chick should have one-half square foot or more of floor space for the first four to five weeks. If broilers are to be housed indoors until ready for market, one square foot of floor space per bird is sufficient. However, if you want to raise layers, you will require about two square feet of floor space per bird for the egg-type birds, and 2½ to three square feet per bird for the dual-purpose birds.

2. **DRAFT-FREE VENTILATION.** An adequate amount of air movement through the poultry house is important for a variety of reasons: it supplies the birds with oxygen; prevents the buildup of carbon dioxide and ammonia, which in excess are harmful, and helps to regulate temperature. Good ventilation is needed to remove excess moisture, in order to keep the litter dry and to help control diseases.

The amount of ventilation required depends upon the season and the age of the birds. During the winter months, ventilation is necessary, but it is equally important to keep the birds away from drafts. The best arrangement for winter ventilation is to tightly close three sides and provide openings on the south wall of the house. The openings should be fairly high in the wall, since moist air is light and rises towards the ceiling. The openings should be covered with burlap in severe cold weather. When the weather is very warm, the birds need plenty of fresh air to keep cool. Cross ventilation becomes very important, therefore windows should be completely removable. The openings should be covered with a ¾-inch mesh netting to keep sparrows outside.

It is important to remember that young birds are much more sensitive to drafts than older birds.

3. **LIGHT.** For the first 48 hours give your chicks 24 hours of light so that they can find the feeders and waterers. One 25-watt light bulb will provide enough light for a 10 ft. x 10 ft. house. Once the chicks have found the feeders and waterers you can take advantage of natural day light.

Having windows on the south side of the house will allow more sunlight to enter the house. Clean the windows once a week to give maximum light. Covering the inside of the windows with a wire mesh screen will prevent the birds from flying into the windows and breaking them. When the weather is warm, remove the windows to improve air circulation.

4. **TEMPERATURE.** Young chicks are unable to maintain their body temperature without an additional heat source. A brooder is a device used to produce heat to protect the chicks from the cold. The temperatures at which chicks are comfortable varies with the age of the chicks, and are as follows:

Temperature	Age of Chicks
95 F	1 day to 1 week
90 F	1 week to 2 weeks
85 F	2 weeks to 3 weeks
80 F	3 weeks to 4 weeks
75 F	4 weeks to 5 weeks
70 F	5 weeks to 6 weeks

BROODER TEMPERATURE

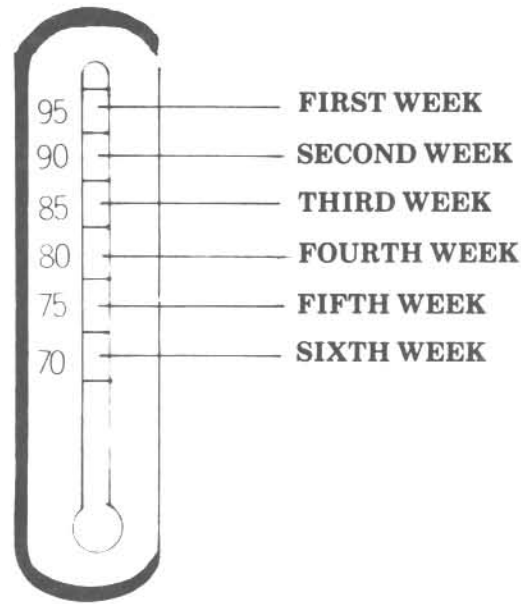

At six weeks of age, the birds should be well-feathered and supplemental heat is no longer needed.

A couple of thermometers will help you to know when the temperature is right. Hang one just under the edge of the brooder about two inches from the floor. Place the other some distance away from the brooder so that you can tell whether you are keeping the brooder at the right temperature.

It is extremely important to have a reliable source of heat. Gas and electric brooders, infrared heat lamps, and even ordinary light bulb brooders are all good sources of heat. The type of brooder you select will depend upon convenience, installation costs and operating costs.

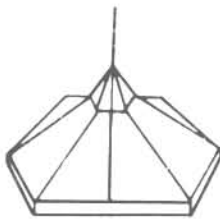

Gas brooder

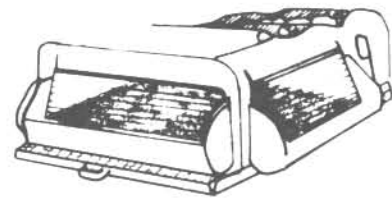

Electric brooder

Brooder for 25-50 Chicks

A brooder heated by an electric light bulb can be used to brood 25 to 50 chicks. To adjust the temperature in the unit, change the bulb size.

If you are raising 100 or fewer chicks, then one 250-watt infrared lamp may be preferred because the initial cost is very low, and the unit is convenient to use. Infrared bulbs are made of hard glass and have built-in reflectors. The hard-glass (pyrex-type) lamps are not as likely to shatter as the non-pyrex-type lamps if water splashes on them.

Infrared brooders are available commercially, or you can build a unit using the following guidelines.

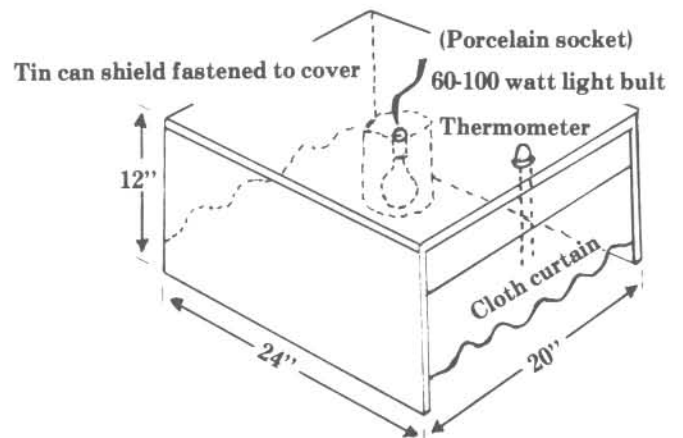

Brooder for 25-50 chicks

Be sure the lamp is equipped with a porcelain socket; plastic ones will not withstand the heat. The electric cord, switch, and plug should all be rated well above the total 250 wattage passing through the system. Suspend the infrared bulbs by an adjustable chain 18 inches above the floor. Watch the chicks carefully to see if they are comfortable. Remember, that with an infrared lamp you are heating the chicks only and not the air temperature, so air temperature measurements cannot be used as a guide to chick comfort.

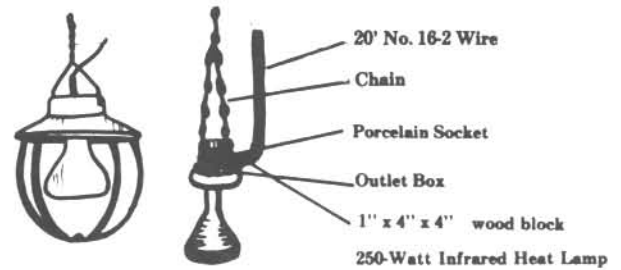

A satisfactory infrared bulb brooding unit for up to 75 chicks.

Just Right

A contented peep and evenly distributed chicks indicates comfortable conditions.

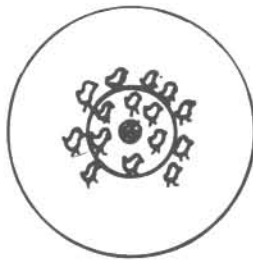

Too Drafty

When the chicks chirp and form wedge, there is a draft.

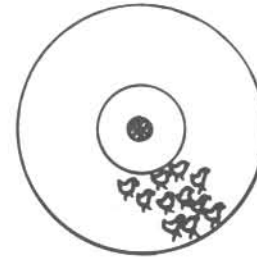

Too Cold

If too cold, the chicks will chirp and pile up under the brooder.

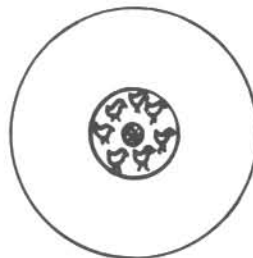

Too Hot

If the chicks move away from the heat source and are drowsy, the temperature is too warm.

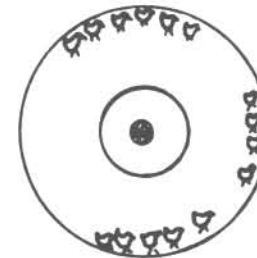

Use your chicks as a guide for the correct brooding temperature.

BROODER GUARDS AND LITTER

A brooder guard is a circular fence designed to keep the chicks from wandering from the heat and getting chilled. It also eliminates corners to avoid piling and shields the chicks from drafts. Keep the chicks close to the brooder by placing the brooder guard two or three feet outside the edge of the brooder. After seven to 10 days the guard can be removed. Brooder guards can be made from an assortment of materials, but 12-inch wide corrugated paper is the best.

Cover the floor of your pen with three inches of

clean, dry litter. The litter will keep the floor dry and warm, odorless, and prevent a buildup of disease-producing organisms.

Wood shavings and sawdust are the most popular litter materials used; but other materials such as crushed cane, crushed corn cobs, or chopped straw work just as well.

Stir the litter frequently to keep it dry and loose. Occasionally add fresh litter until it is four to six inches deep.



A corrugated cardboard chick guard should be placed two to three feet away from the brooder to confine the chicks to the heated area.

5. EASY ACCESS TO FEED AND WATER.

Seventy percent of the cost of raising chickens is due to feed cost. This is an investment rather than an expense, because the better the birds are fed, the greater the return in eggs and/or meat. Make sure the birds always have plenty to eat. Never fill the feeders more than half full; otherwise you will be wasting feed and money.

Water is the cheapest nutrient, yet it is often the most neglected. Water softens the feed and aids digestion. It serves as a carrier of waste products, is involved in temperature regulation, and acts as a lubricant in body tissues.

Give day-old chicks eight percent sugar water to drink (1½ cups of sugar per gallon of water) for the first day. The sugar serves as a quick and easy to use energy source for thirsty chicks. If possible, give the water to the day-old chicks three to five hours before giving the feed. This will get the chicks off to a good and healthy start.

When selecting waterers and feeders, keep in mind that chicks grow fast; and feeding and watering space and the size of the equipment need to increase to meet their needs. Chicks develop both a scratching and roosting behavior, which can lead to feed being scattered over the litter, and to having droppings in the feed if the birds are permitted to perch on the feeders.

It is also important to remember that the sooner the chicks are placed in the brooder house and allowed to eat and drink, the better their growth and performance. For the first few days place the feed in feeder

trays. A cardboard box, cut off to two inches high makes an excellent feeder tray. Add some small chick feeders, and gradually remove all the feeder trays. Make sure the chicks have found the regular chick feeders before removing all the trays. Use chick-size feeders for the first two weeks.

Provide one inch of feeder space, add both sides of the feeder. For example, if your chick feeder is 12 inches long, then it can handle 24 chicks.

From the second week on, the tube-type feeders can be used. These are more conveniently and more practical than the trough feeders. The tube-type feeders are suspended from the ceiling, and can be easily raised, keeping up with the height of the growing birds. These feeders should be adjusted to the height of the birds' back. To determine the linear space of a round feeder, multiply the base diameter of the container times 3.14. For birds age two to six weeks provide two inches of feeder space per bird.

If you intend to use only trough feeders for your birds, the feeders should increase in depth, breadth, length and height as the birds grow. From the second through the sixth week, use the medium-sized feeders, and provide two inches per chick.



Feeder tray

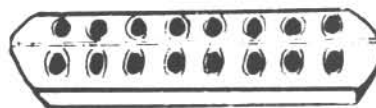

Chick feeder

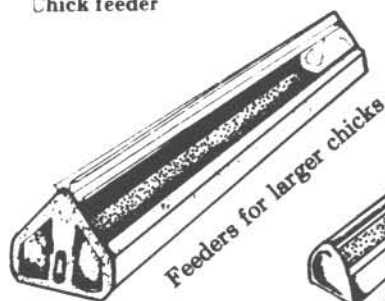
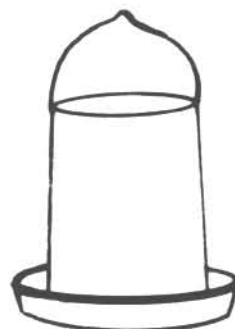

Feeders for larger chicks

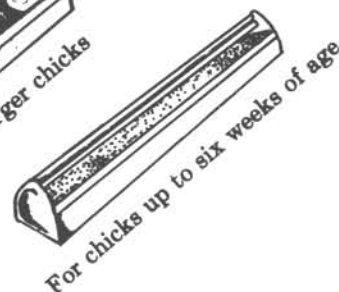

For chicks up to six weeks of age

Chicks should always have plenty of clean, fresh water. Use six 1-quart fountain-type waterers per 100 chicks during the first week. Replace at end of one week with two 2-gallon waterers. It is a good practice to place the water fountains upon frames two feet square made of 1" x 2" boards covered with ½-inch mesh hardware cloth. This will help to keep the waterers clean and the birds away from the damp litter surrounding the water fountain. From the fourth week on, provide two 5-gallon waterers for each 100 birds. Place waterers on wire bottom stands made of 1" x 4" boards to keep the water clean.

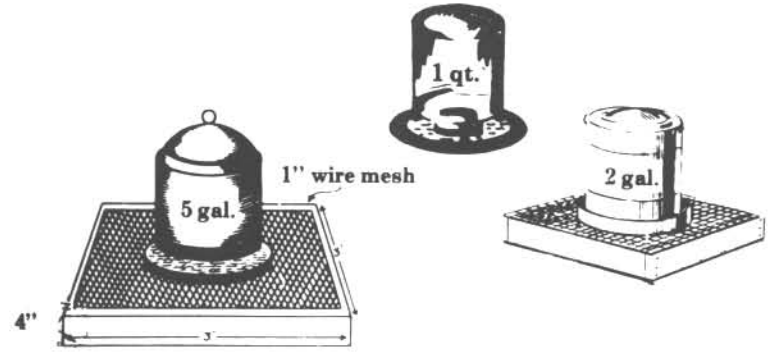

A guide for the placement of equipment around the brooder.

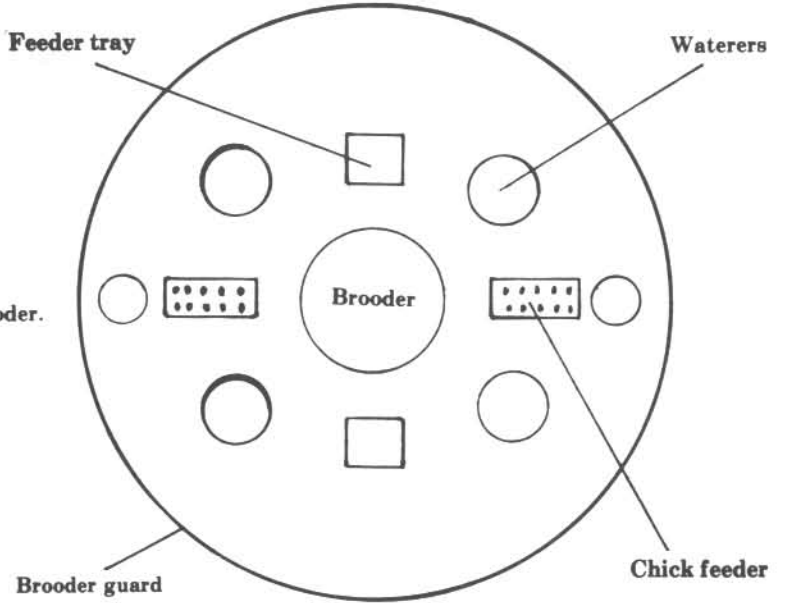

POULTRY NUTRITION

The commercial poultry feeds available today are the result of years of research. The rations contain 30 or 40 ingredients, and are designed to meet the specific needs of the birds. Young chickens or broilers grown for meat are fed differently from pullets raised for their eggs. Because the nutrient requirements vary with the age of the birds, feed manufacturers produce a starter and finisher ration for broilers, and a starter, grower, and layer ration for chickens intended for laying eggs.

Feed chicks a starter ration from the very first day, and keep them on the starter until they reach six weeks of age. The starter diet has the most protein. As the birds mature they need a lower percentage of protein and a higher level of energy.

Once the chicks are six weeks of age, give them either a finisher diet (to broilers) or a grower diet (to pullets or cockerels saved for breeding purposes). Feed broilers a finisher diet until they weight about four pounds, and then process. Feed the pullets and cockerels a grower until they reach 20 weeks of age or until the pullets start to lay eggs. When egg production begins, feed them a layer ration.

The minimum requirements for protein, calcium, and phosphorus in poultry feeds are given in Table 1. This table should help you to determine what type of feed to purchase for your birds.

Table 1. Minimum protein, calcium and phosphorus requirements for broilers, pullets and laying hens.

	Protein %	Calcium %	Phosphorus %
Broilers			
Starter	23	0.9	0.5
Finisher	20	0.8	0.5
Pullets			
Starter	20	0.9	0.5
Grower	17	0.8	0.5
Laying Hens			
Layer	16-18	3.0	0.5

The most common mistake made is feeding the wrong feed. Do not give your chickens scratch grain or table scraps. Do not mix a complete commercial ration with scratch grains. Cracked corn, for example, is low in protein. By mixing cracked corn with a complete commercial grower ration, you reduce the protein level, as well as the vitamin and mineral content of the diet. The birds will not grow as well. They will be less resistant to disease, and the birds will pick and eat their feathers to try to compensate for the missing protein. Feather picking will lead to cannibalism.

The second most common mistake made is not feeding enough. During the first 20 weeks, you can expect each dual-purpose type pullet to eat about 20 pounds of feed. Table 2 shows you the amount of feed you will need to buy for your poultry project.

Table 2. Amount and Kind of Feed Required for 25 Pullets by Age

Age	Amount and Kind of Feed
0-6 weeks	100 lbs. of starter
6-20 weeks	400 lbs. of grower
Start laying-on	100 lbs. of layer every 2 weeks

When you buy feed, you may have the option of buying a nonmedicated feed or a medicated feed. Poultry feeds which are medicated are used to prevent or treat disease. The two most common medications added to feeds are coccidiostats and/or antibiotics.

Coccidiostats are drugs that are added to feed at low levels and fed continuously to prevent a disease called, coccidiosis. Coccidiosis is a disease of the intestinal tract, caused by microscopic single-celled animals called protozoa. Birds having this disease may appear sleepy, pale, ruffled and unthrifty. They may also have bloody droppings.

Broilers are fed a ration containing a coccidiostat until the last week before processing. An unmedicated feed is fed this last week.

Young chickens intended for laying eggs are also susceptible to coccidiosis. They should receive a coccidiostat until they are about 16 weeks of age. The medicated feed is then replaced with a non-medicated feed. Older chickens are more resistant to coccidiosis, however, if an outbreak does occur it can be controlled by treating in the water.

Poultry feeds may also contain some antibiotics. They are usually added at low levels to prevent minor diseases and to improve the growth performance of broilers. Higher levels of antibiotics are used to treat certain diseases. They are usually given in water.

Always remember to read the labels on medications, and always follow the instructions and recommended withdrawal periods before eating meat or eggs from treated birds.

Disease Prevention

The first step in raising chickens is to start with healthy chicks. Then it is up to you to provide clean, comfortable housing for the birds. Use preventive management to avoid disease and parasite problems.

Start with a clean house and equipment. If the house was used earlier, scrub the house with a commercial disinfectant such as creosol or with hot lye water (one pound of lye to 10 gallons of hot water). Let the house dry several days before placing the chicks in the house. Disinfect waterers and feeders with a quaternary ammonium solution. Wear protective clothing, gloves, and goggles when using creosol or lye.

Keep feed in metal cans with tight lids to keep mice and rats out. Repair holes in the screen windows to prevent birds and small animals from entering the house.

Remove sick or dead birds from the poultry house as soon as they are found. Dispose of dead birds promptly by burying them deeply to discourage animals from digging.

Prevent cannibalism and feather picking by buying chicks that have been debeaked at the hatchery, or clip off the top of the beak with a dog's toe nail clippers. Overcrowding, nutrient deficiencies, poor ventilation, too little drinking and eating space, too much light, and the appearance of blood on an injured bird are factors which lead to picking.

External Parasites

Mites and lice are the most common parasites found on chickens. Consult your county Extension agent for advice on pesticides safe to use on or around poultry. Carefully follow instructions when using pesticides.

Internal Parasites

The large roundworm can become a problem for small flocks. A few worms do not cause any harm. If you see worms in the droppings, then you need to treat the birds. Your county Extension agent can recommend a worming compound.

Vaccination

Earlier we suggested that you have the hatchery vaccinate the chicks against Marek's disease. The protection given by the vaccine is well worth the added cost. Marek's disease is caused by a virus. It may result in a loss of weight, paralysis of legs or wings, and sudden death.

Although it is difficult to secure small lots of vaccine, it may be necessary to vaccinate your flock against fowl pox, Newcastle disease, and bronchitis if these diseases have been a problem in previous flocks. See Table 3 for a suggested vaccination schedule.

Fowl pox is caused by a virus, and shows up as blisters and scabs on the combs and wattles. Newcastle disease and bronchitis are viral respiratory diseases.

Table 3. Vaccination Schedule indicating type of vaccine, age to vaccinate, and method of vaccination.

Vaccine	Age of Bird	Method
Newcastle-Bronchitis	10 days	water
Newcastle-Bronchitis	6 weeks	water
Fowl Pox	12 weeks	wing stab
Newcastle-Bronchitis	4 months	water

If you do not vaccinate, do not allow visitors around your flock. Birds which are entered in poultry exhibits may be exposed to disease. Sell the birds or keep them separate from the rest of the flock for at least two weeks after their return home. If they have picked up a disease, it will appear before the birds are returned to the flock.

Growing Pullets

The growing period follows the brooding period. It begins when the birds are about six weeks of age and lasts until the pullets are ready-to-lay. Good management is very important at this time. The care you give your birds now will determine how many eggs you will collect later on. You should practice the following management factors.

1. **Space.** Each pullet should have plenty of room to grow. Egg-type birds, such as Leghorns need about two square feet of floor space per bird. The larger dual-purpose birds, such as the Black-Sex Link or Rhode Island Red, require about 2½ to three square feet per bird.
2. **Draft-Free Ventilation.** Starting a flock in March or April means that the weather should be warm and mild when the birds are 12 weeks of age. Pullets need lots of fresh air. Open the windows during the day to get good cross ventilation. If the nights are still cool, adjust the windows to avoid drafts.

3. **Lighting.** Take advantage of natural day light. Do not use artificial lights until the pullets start to lay.
4. **Temperature.** If you have managed your flock well during the brooding period, the birds should be well feathered and do not require heat. However, cold temperatures at night may make it necessary for you to provide additional heat during the early growing period. Remember to keep your birds as comfortable as possible.
5. **Access to Feed and Water.** From six to 12 weeks of age, allow three inches of feeder space per bird. Your pullets should have feed available at all times. When adding feed to the feeder, push all the remaining feed to one end. Do not put fresh feed on top of the old feed. Never fill the feeder over half full.
6. **Roosts.** Equip your house with roost poles for the birds to perch on at night. Roost poles can be made from two-inch stock with slightly rounded upper edges. Roost poles should be spaced 13 to 15 inches apart. They should provide eight to 10 inches of space per bird. Wire netting at the ends and underneath the roosts will prevent the birds from getting into droppings under the roosts.

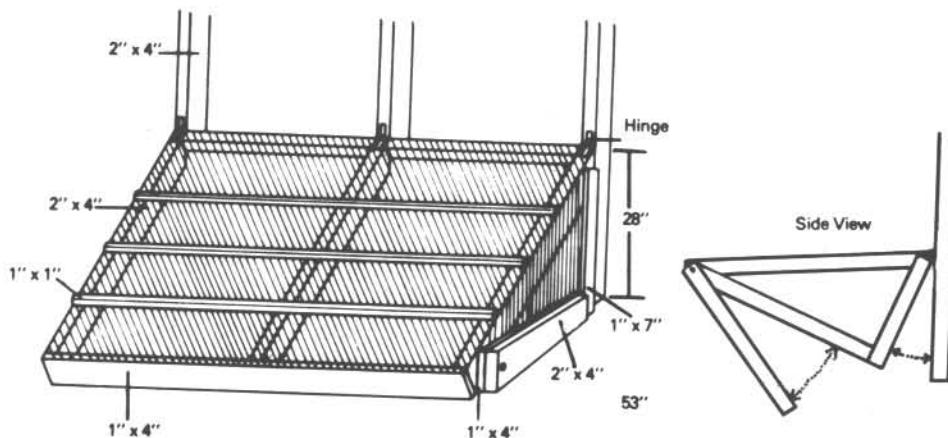

Managing Layers

Much of what you have already learned in the poultry project applies to the care of birds that are twenty weeks and older. The brooder and rearing quarters can be used as the laying house, or the ready-to-lay pullets can be moved to a separate house. In either case, be sure to consider the following management factors.

1. **Space.** Plan on each bird having available at least three square feet of floor space.
2. **Ventilation.** The amount of ventilation needed depends upon the season. During the summer, keeping hens cool is very important. If you can open up two sides of the house, you will increase air movement. During cold weather, ventilation should be from the South side of the house. Openings that drop down from the top or tip in are best.
3. **Light** When raising chickens for egg production, it is recommended that the house have artificial lighting. The lights are used to provide a uniform period of light stimulation, and not to give the hens more time to eat. It is through the stimulation of light that the ready-to-lay pullet reaches early sexual maturity, and begins to lay more eggs. Ready-to-lay pullets need about 14 hours of light daily. Chicks hatched in the spring receive an adequate amount of natural light during the brooding and growing phase. However, due to the decrease in day length in the fall and winter, it is necessary to extend the daylight hours with artificial light. The ready-to-lay pullets should be given extra light beginning in September, and this should be continued until the natural day length reaches 15 hours. The lights may be turned on in the morning at 6:00 a.m. for two hours, and then turned on again in the evening at 6:00 p.m. until 8:00 p.m. It is sometimes difficult to get up early and turn the lights on or to turn the lights off at night. An inexpensive time clock set to control the lights automatically will generally give the best results.
4. **Temperature.** Laying birds do not need artificial heat, unless the house is poorly insulated. Keep the house free from drafts. Thaw the waterers promptly if they become frozen, or use an immersible water heater to keep the water from freezing. If the birds are exposed to extreme cold, the birds will stop laying, and their combs and wattles may freeze. In the summer the poultry house should have at least three inches of dry litter. When the weather starts to get colder, gradually add fresh litter until it is at least four to six inches deep. The built up litter provides a warm, dry floor. Stir the litter often to keep it in good shape. If an area becomes caked or wet, clean out the wet litter and replace with fresh.
5. **Access to Feed and Water.** Your flock should always have a fresh supply of commercial laying mash on hand. Water is very important to the laying flock. Without fresh, clean water, the birds will not eat and will go out of production.

6. **Roosts.** Check the wire mesh around the roosts and make sure the wire is not broken. Sharp points on the wire can injure the foot pads of the chickens and cause an infection to develop.
7. **Nests.** Provide one nest for every four hens. Keep clean nesting material, such as wood shavings in the nest at all times. Place nests 18-20 inches above the floor. Individual nests should be 10-14 inches wide, 12-14 inches high, and 12 inches deep. Perches below the entrance help keep the nest clean.

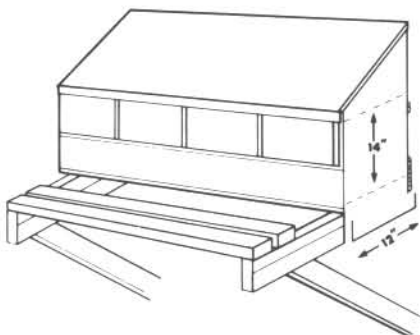

Egg Care

Most eggs are laid with a clean shell. To keep eggs clean, change the nesting material often. Gather the eggs at least twice a day. Dirty eggs should be buffed clean with emory cloth.

Eggs should be kept in the refrigerator until used. For information on grading eggs, ask your county Extension agent for a copy of "Getting Acquainted With Marketing Chicken and Egg Products," 4-H Member Guide — Unit 4.

Culling

Culling is the removal of sick, or injured birds, from the flock. Culling, if done right, will reduce feed costs and may prevent the spread of a disease. Culling is a daily task. Separate sick or injured birds from the flock as soon as you see them. Try to learn the cause of the problem before disposing the bird. The information may be useful in preventing other birds in your flock from getting sick.

Toward the end of the first year of production, some hens may stop laying. You may wish to pick out these loafers, and process them for home use. It is easy to tell the difference between good layers and poor layers, once you have learned what to look for.

Good Layers Have:

- Bright red comb
- Soft pliable abdomen
- Large moist vent
- 3 to 5 fingers' spread between pelvic bones

Poor Layers Have:

- Dull shriveled comb
- Hard fatty abdomen
- Small, round, dry vent
- 1 to 2 fingers' spread between pelvic bones

It is normal for hens that have been laying for 12-14 months to take a rest. You can now decide to either process the flock for meat and make room for new pullets or keep the hens for another production cycle.

Project Questions

Answers to questions 1-5 should be written into the manual before the chicks are two weeks of age.

1. What things must be done before the chicks arrive? _____

2. What are the four most important things a day old chick needs?
 1. _____
 2. _____
 3. _____
 4. _____
3. How do chicks act when they are:
 - A. Too hot _____

 - B. Too cold _____

 - C. Comfortable _____

4. Litter on the floor should be _____ inches deep when the chicks are placed in the house.
5. During the first week, the brooder temperature should be around _____ °F.

Answers to questions 6-10 should be written into the manual before the chickens are 14 weeks of age.

6. The rearing or growing period begins when the birds are about _____ weeks of age and lasts until _____.
7. The use of artificial lights during the growing period is not recommended. True False
8. During the growing period, birds should be well feathered and do not require extra heat unless it is very cold. True False.
9. Birds that are in the growing period should be fed a commercial diet which contains _____% protein.
10. Pullets use roost poles during the day. True False

Answers to questions 11-15 should be written into the manual before the chickens are 25 weeks of age.

11. Each laying pullet should have at least _____ square feet of floor space.
12. Light in the laying house provides a _____ period of light stimulation.
13. Starting at about 20 weeks of age, ready-to-lay pullets need about _____ hours of light daily.
14. During the winter, the litter should be at least _____ to _____ inches deep.
15. Culling is the removal of 1. _____ 2. _____ 3. _____.

Project Experiment

Experiment: Effectiveness of Different Nesting Material

You will need several different kinds of nesting material such a shavings, straw, sawdust, and granite grit. Test a different material each week. Use the following record to record your results.

EXPERIMENT RECORD #1

Week	Kind of nesting Material	Number of eggs laid	Number of dirty eggs	Number of eggs broken in the nest	Number of eggs cracked
1.					
2.					
3.					
4.					

Conclusions:

1. What did you learn from this test? _____

2. Did changing nesting material cause a change in the use of the nests? _____
3. Did the hens prefer one kind of nesting material over that of another? _____
4. Which kind of nesting material seemed best to you? _____

5. Did the hens scratch more of one kind of nest material out of the nest than they did of the other materials? _____

What You Can Show Others

- () How to build a small brooder
- () How to vaccinate chicks
- () How to select the right feed
- () How to tell the difference between a good layer and a poor layer
- () How to care for eggs

Check the practices you did and list groups of persons that saw you do these things.

Management Timetable*

	Age of Chicks	Fill in Dates
1. Order chicks well in advance.	---	
2. Clean and disinfect brooder house.	---	
3. Clean and disinfect brooder and equipment.	---	
4. Provide ½ sq. ft. floor space per chick.	---	
5. Check house for drafts.	---	
6. Clean light bulb.	---	
7. Cover floor with 3 inches of litter.	---	
8. Place brooder guard around brooder.	---	
9. Start brooder and adjust temperature at least two days before chicks arrive.---		
10. On day chicks arrive, fill waterers. Provide six one-quart size waterer for each 100 chicks.	First day	
11. When chicks arrive, place under brooder immediately and make sure they find water.	First day	
12. Three to 5 hours after chicks have had water, provide feed in chick trays and feeders.	First day	
13. Watch and keep uniform temperature of 90-95°F.	1-7 days	
14. Allow one inch of feeder space per chick.	1-7 days	
15. Stir litter often to prevent caking.	Regularly	
16. Reduce temperature of brooder approximately five degrees each week until no artificial heat is needed.	Weekly	
17. Remove brooder guard.	7-10 days.	
18. Vaccinate chicks for Newcastle and bronchitis.**	10 days	
19. Clean and disinfect waterers often.	Regularly	
20. Provide two 2-gallon waterers per 100 chicks.	2 through 4 weeks	
21. Increase feeder space to 2 linear inches per bird.	2 through 6 weeks	
22. Provide two 5-gallon waterers per 100 birds.	4 weeks	
23. Vaccinate flock for Newcastle and Bronchitis.**	6 weeks	

24. Increase feeder space to 3 linear inches per pullet.	6 through 20 weeks
25. Feed a grower ration.	6 through 20 weeks
26. Vaccinate flock for fowl pox.**	12 weeks
27. Re-vaccinate for Newcastle and bronchitis.**	16 weeks
28. Feed a laying ration.	Onset of laying
29. Check ventilation.	Regularly
30. Provide 14 hours of light.	Onset of laying through laying period
31. Check time clocks.	Regularly
32. Collect eggs twice a day.	Throughout laying period

**Use Form 659 and keep accurate records.*

***Vaccination program is optional*

REFERENCES

Animal Husbandry Research Division, ARS, 1977. *Farm Poultry Management*, USDA, Washington, D. C. Farmers' Bulletin No. 2197.

Goan, H. C., 1977. *4-H Poultry and Egg Judging*, University of Tennessee, Knoxville, Tennessee. Publication 1977.

Hauver, W. E., *et al*, 1977. *Egg Grading manual*, USDA, Consumer Marketing Service, Washington, D. C. Agriculture Handbook No. 75.

Holleman, K. A., 1978. *Small Poultry Flocks*, USDA Farmers' Bulletin No. 2262.

Mullet, R. P., 1971. *Poultry Pests*, University of Tennessee, Knoxville, Tennessee. Publication No. 393.

Tugwell, R. L., and Goan, H. C., 1977. *Poultry Disposal Pit*, University of Tennessee, Knoxville, Tennessee. Publication No. 751.

Tugwell, R. L., and Goan, H. C., *The Home Poultry Flock*, University of Tennessee, Knoxville, Tennessee. Publication No. 752.

Visit the Agricultural Extension Service Web site at <http://www.utextension.utk.edu/>
and the 4-H Web site at <http://www.utextension.utk.edu/4H/>

PB915-2M-4/03 (Rep) E12-5015-00-066-03

The Agricultural Extension Service offers its programs to all eligible persons regardless of race, color, national origin, sex, age, disability, religion or veteran status and is an Equal Opportunity Employer. COOPERATIVE EXTENSION WORK IN AGRICULTURE AND HOME ECONOMICS.
The University of Tennessee Institute of Agriculture, U.S. Department of Agriculture, and county governments cooperating in furtherance of Acts of May 8 and June 30, 1914. Agricultural Extension Service Charles L. Norman, Dean